

## B/W Video Camera Module XC-E Series



The XC-E Series are compact, light-weight one-piece black and white cameras incorporating the latest 1/2 and 1/3 type Interline (IT) CCD which produces new levels of picture detail. With dimensions of 29 x 29 x 32 mm (1 3/16 x 1 3/16 x 1 5/16 inches)\*, these cameras can easily be installed in places where installation was previously difficult for other larger cameras.

The XC-E Series offer three different model ranges that only differ in spectral sensitivity as to suit various application environments. The XC-ES Series (XC-ES50/ES50CE, XC-ES50L/ES50LCE, XC-ES51/ES51CE and XC-ES30/ES30CE) are standard models for general use under visible light conditions. The XC-EI Series (XC-EI50/EI50CE and XC-EI30/EI30CE) offer excellent near-infrared sensitivity. Under low light conditions or when used with IR LED illumination systems, these cameras provide clear images. The XC-EU Series (XC-EU50/EU50CE) offer near-ultraviolet sensitivity in the i-line, or 365 nm, range. The short wavelength allows the XC-EU Series to capture very fine detail. All models have identical dimensions and controls, making them easy to interchange. A variety of settings are available for differing subject and lighting conditions. All camera control switches are accessible from the outside of the camera. Excellent vibration and shock characteristics make these cameras ideal for demanding machine vision applications.

\* The XC-ES50L/ES50LCE, which are L-type versions of the XC-ES50/ES50CE, measure 29 (W) x 42.5 (H) x 43.8 (D) mm (1 3/16 x 1 11/16 x 1 3/4 inches).



### Features

- XC-ES50/ES50CE/ES50L/ES50LCE/ES51/ES51CE/EI50/EI50CE/EU50/EU50CE: 1/2 type IT CCD
- XC-ES30/ES30CE/EI30/EI30CE: 1/3 type IT CCD
- Compact and light weight: 29 (W) x 29 (H) x 32 (D) mm, 50 g except for XC-ES50L/ES50LCE: 29 (W) x 42.5 (H) x 43.8 (D) mm, 110 g
- Near-infrared sensitivity: XC-EI50/EI50CE, XC-EI30/EI30CE
- Near-ultraviolet sensitivity: XC-EU50/EU50CE
- Minimum illumination at F1.4:
  - 0.3 lx: XC-ES50/ES50CE/ES30/ES30CE
  - 3.0 lx: XC-ES50L/ES50LCE
  - 0.1 lx: XC-EI50/EI50CE
  - 0.2 lx: XC-ES51/ES51CE/EI30/EI30CE
- High S/N Ratio: 60 dB
- Electronic shutter function:
  - 1/100 to 1/10,000 s: EIA, 1/120 to 1/10,000 s: CCIR
- Flexible trigger shutter function
- Scanning system: 2:1 interlaced
- Frame/field exposure
- Restart/reset function
- Synchronization: internal/external (HD/VD)
- High shock and vibration tolerance

## Standard model

XC-ES50/ES50CE  
 XC-ES50L/ES50LCE  
 XC-ES51/ES51CE  
 XC-ES30/ES30CE



Applicable wavelength range  
 400-770 nm



## Near IR model

XC-EI50/EI50CE  
 XC-EI30/EI30CE



Applicable wavelength range  
 400-770 nm



## UV model

XC-EU50/EU50CE



Applicable wavelength range  
 300-420 nm

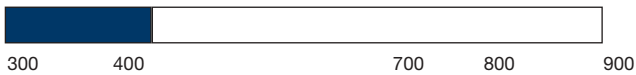

The XC-EU50/EU50CE models are compact and light-weight cameras that have near-ultraviolet sensitivity in the i-line, or 365 nm, range. Examples of typical application areas are PCB and solder inspection, document proofing, microscopy, medical and cosmetics applications. Using UV lighting, the short wavelength allows the XC-EU50/EU50CE models to capture clearly very fine detail and surface structures, which cannot be detected using visible or IR lighting, including very small scratches, dust or blemishes, as well as special fluorescent materials.

## Spectral response

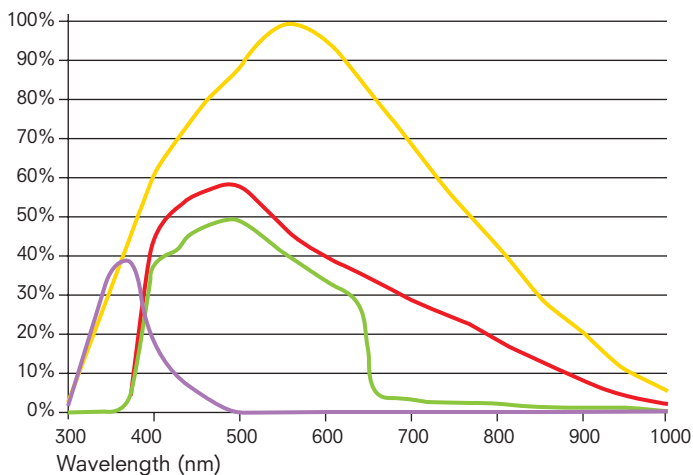

- XC-ES/ST Series
- XC-EI Series
- XC-EU Series
- Standard CCD with IR Cut Filters

Note following differences between models:

- XC-EI models are more sensitive than XC-ES models, not only in near-IR range but in visible range as well.
- XC-ES51/ES51CE has an improved sensitivity over XC-ES50/ES50CE.
- XC-EU models are only sensitive in near-UV range and are not susceptible to disturbance from surrounding visible light.
- XC-ES50L/ES50LCE include an IR Cut Filter.

## Accessories

Compact camera adaptor

### DC-700/700CE

- Compact, lightweight (700 g, 1 lb 8 oz)
- External sync IN/OUT
- Trigger input / WEN output
- New EIAJ standard 12 pin connector
- Dimensions: 110 (W) x 53 (H) x 160 (D) mm (4 3/8 x 2 1/2 x 6 3/8 inches)



### 12 pin camera cable (CE standard)

- CCXC-12P02N (2 m)
- CCXC-12P05N (5 m)
- CCXC-12P10N (10 m)
- CCXC-12P25N (25 m)



Tripod adaptor

### VCT-333I

- ABS
- Approx. 6.1 g (0.2 oz)
- Dimensions: 18 (W) x 6 (H) x 27 (D) mm (2 7/32 x 1/4 x 1 1/8 inches)



# XC-E Series Specifications

|  | XC-ES50  | XC-ES50L   | XC-ES51   | XC-ES30  | XC-EI50         | XC-EI30         | XC-EU50         |
|--|--|--|-----------|--|-----------------|-----------------|-----------------|
| Image device                                       | 1/2 type IT CCD  |  |           | 1/3 type IT CCD                                      | 1/2 type IT CCD | 1/3 type IT CCD | 1/2 type IT CCD |
| Effective picture elements                         | 768 (H) x 494 (V)  |  |           |  |                 |                 |                 |
| Signal system                                      | EIA (standard)   |  |           |  |                 |                 |                 |
| Horizontal frequency                               | 15.734 kHz   |  |           |  |                 |                 |                 |
| Vertical frequency                                 | 59.94 Hz   |  |           |  |                 |                 |                 |
| Cell size (μm)                                     | 8.4 x 9.8  |  |           | 6.35 x 7.4   | 8.4 x 9.8       | 6.35 x 7.4      | 8.4 x 9.8       |
| Lens mount   | C mount  |  |           |  |                 |                 |                 |
| Flange back  | 17.526 mm  |  |           |  |                 |                 |                 |
| Sync system  | Internal/External (auto)   |  |           |  |                 |                 |                 |
| External sync system                               | HD/VD (2 to 5 Vp-p)  |  |           |  |                 |                 |                 |
| External sync frequency                            | ± 1 %  |  |           |  |                 |                 |                 |
| Jitter Less than                                   | ± 50 nsec  |  |           |  |                 |                 |                 |
| Scanning system                                    | 2:1 Interlaced   |  |           |  |                 |                 |                 |
| Video output                                       | 1.0 Vp-p, negative, 75 Ω unbalanced  |  |           |  |                 |                 |                 |
| Horizontal resolution                              | 570 TV lines   |  |           |  |                 |                 |                 |
| Sensitivity (Gamma ON, MIN GAIN, No IR cut filter) | 400 lx F5.6  | 400 lx F4  | 400 lx F8 | 400 lx F4  | 400 lx F11      | 400 lx F8       | -               |
| Minimum illumination*                              | 0.3 lx   | 3.0 lx   | 0.2 lx    | 0.3 lx   | 0.1 lx          | 0.2 lx          | -               |
| S/N ratio  | 60 dB  |  |           |  |                 |                 |                 |
| Gain   | AGC/Manual selectable  |  |           |  |                 |                 |                 |
| Gamma  | ON/OFF selectable  |  |           |  |                 |                 |                 |
| Normal shutter                                     | 1/100 to 1/10,000 s  |  |           |  |                 |                 |                 |
| External trigger shutter**                         | 1/4 to 1/10,000 s  |  |           |  |                 |                 |                 |
| Power requirements                                 | DC 12 V (+9 to +16 V)  |  |           |  |                 |                 |                 |
| Power consumption                                  | 1.6 W  |  |           | 1.4 W  | 1.6 W           | 1.4 W           | 1.6 W           |
| Dimension (W) x (H) x (D)                          | 29 x 29 x 32 mm<br>(1 3/16 x 1 3/16 x 1 5/16 inches)                             | 29 x 42.5 x 43.8 mm<br>(1 3/16 x 1 11/16 x 1 3/4 inches) |           | 29 x 29 x 32 mm<br>(1 3/16 x 1 3/16 x 1 5/16 inches) |                 |                 |                 |
| Mass   | 50 g (2 oz)  | 110 g (4 oz)   |           | 50 g (2 oz)  |                 |                 |                 |
| Operating temperature                              | -5 to +45 °C (23 to 104 °F)  |  |           |  |                 |                 |                 |
| Operating humidity                                 | 20 to 80 %   |  |           |  |                 |                 |                 |
| Storage temperature                                | -30 to +60 °C (-22 to +140 °F)   |  |           |  |                 |                 |                 |
| Storage humidity                                   | 20 to 95 %   |  |           |  |                 |                 |                 |
| Vibration resistance                               | 10 G (20 to 200 Hz)  |  |           |  |                 |                 |                 |
| Shock resistance                                   | 70 G   |  |           |  |                 |                 |                 |
| MTBF   | 126,000 hrs.   |  |           |  |                 |                 |                 |
| Regulatory compliance                              | UL1492, FCC Class B Digital Device, CE (EN61326/97 + A1/98), AS4251.1 + AS4252.2 |  |           |  |                 |                 |                 |
| Supplied accessories                               | Lens mount cap (1), Operating instructions (1)                                   |  |           |  |                 |                 |                 |

\* (F1.4, AGC ON, without IR cut filter) \*\* Using Dip switch on the rear panel or Using trigger pulse width

|  | XC-ES50CE  | XC-ES50LCE   | XC-ES51CE | XC-ES30CE  | XC-EI50CE       | XC-EI30CE       | XC-EU50CE       |
|--|--|--|-----------|--|-----------------|-----------------|-----------------|
| Image device                                       | 1/2 type IT CCD  |  |           | 1/3 type IT CCD                                      | 1/2 type IT CCD | 1/3 type IT CCD | 1/2 type IT CCD |
| Effective picture elements                         | 752 (H) x 582 (V)  |  |           |  |                 |                 |                 |
| Signal system                                      | CCIR (standard)  |  |           |  |                 |                 |                 |
| Horizontal frequency                               | 15.625 kHz   |  |           |  |                 |                 |                 |
| Vertical frequency                                 | 50 Hz  |  |           |  |                 |                 |                 |
| Cell size (μm)                                     | 8.6 x 8.3  |  |           | 6.5 x 6.25   | 8.6 x 8.3       | 6.5 x 6.25      | 8.6 x 8.3       |
| Lens mount   | C mount  |  |           |  |                 |                 |                 |
| Flange back  | 17.526 mm  |  |           |  |                 |                 |                 |
| Sync system  | Internal/External (auto)   |  |           |  |                 |                 |                 |
| External sync system                               | HD/VD (2 to 5 Vp-p)  |  |           |  |                 |                 |                 |
| External sync frequency                            | ± 1 %  |  |           |  |                 |                 |                 |
| Jitter Less than                                   | ± 50 nsec  |  |           |  |                 |                 |                 |
| Scanning system                                    | 2:1 Interlaced   |  |           |  |                 |                 |                 |
| Video output                                       | 1.0 Vp-p, negative, 75 Ω unbalanced  |  |           |  |                 |                 |                 |
| Horizontal resolution                              | 560 TV lines   |  |           |  |                 |                 |                 |
| Sensitivity (Gamma ON, MIN GAIN, No IR cut filter) | 400 lx F5.6  | 400 lx F4  | 400 lx F8 | 400 lx F4  | 400 lx F11      | 400 lx F8       | -               |
| Minimum illumination*                              | 0.3 lx   | 3.0 lx   | 0.2 lx    | 0.3 lx   | 0.1 lx          | 0.2 lx          | -               |
| S/N ratio  | 60 dB  |  |           |  |                 |                 |                 |
| Gain   | AGC/Manual selectable  |  |           |  |                 |                 |                 |
| Gamma  | ON/OFF selectable  |  |           |  |                 |                 |                 |
| Normal shutter                                     | 1/120 to 1/10,000 s  |  |           |  |                 |                 |                 |
| External trigger shutter**                         | 1/4 to 1/8,000 s   |  |           |  |                 |                 |                 |
| Power requirements                                 | DC 12 V (+9 to +16 V)  |  |           |  |                 |                 |                 |
| Power consumption                                  | 1.6 W  |  |           | 1.4 W  | 1.6 W           | 1.4 W           | 1.6 W           |
| Dimension (W) x (H) x (D)                          | 29 x 29 x 32 mm<br>(1 3/16 x 1 3/16 x 1 5/16 inches)                             | 29 x 42.5 x 43.8 mm<br>(1 3/16 x 1 11/16 x 1 3/4 inches) |           | 29 x 29 x 32 mm<br>(1 3/16 x 1 3/16 x 1 5/16 inches) |                 |                 |                 |
| Mass   | 50 g (2 oz)  | 110 g (4 oz)   |           | 50 g (2 oz)  |                 |                 |                 |
| Operating temperature                              | -5 to +45 °C (23 to 104 °F)  |  |           |  |                 |                 |                 |
| Operating humidity                                 | 20 to 80 %   |  |           |  |                 |                 |                 |
| Storage temperature                                | -30 to +60 °C (-22 to +140 °F)   |  |           |  |                 |                 |                 |
| Storage humidity                                   | 20 to 95 %   |  |           |  |                 |                 |                 |
| Vibration resistance                               | 10 G (20 to 200 Hz)  |  |           |  |                 |                 |                 |
| Shock resistance                                   | 70 G   |  |           |  |                 |                 |                 |
| MTBF   | 126,000 hrs.   |  |           |  |                 |                 |                 |
| Regulatory compliance                              | UL1492, FCC Class B Digital Device, CE (EN61326/97 + A1/98), AS4251.1 + AS4252.2 |  |           |  |                 |                 |                 |
| Supplied accessories                               | Lens mount cap (1), Operating instructions (1)                                   |  |           |  |                 |                 |                 |

\* (F1.4, AGC ON, without IR cut filter) \*\* Using Dip switch on the rear panel or Using trigger pulse width

## Connection Diagram

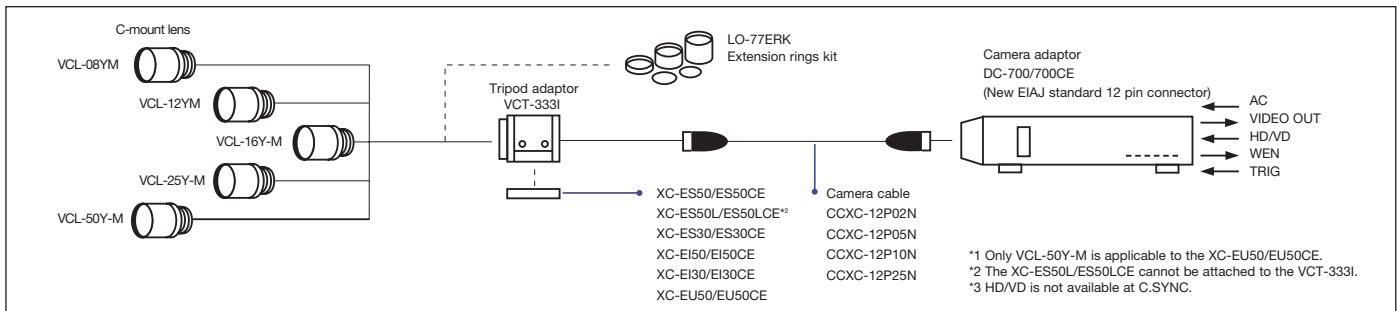

## Dimensions & Rear Panel

XC-ES50/ES50CE/ES51/ES51CE/ES30/ES30CE  
XC-EI50/EI50CE/EI30/EI30CE/EU50/EU50CE

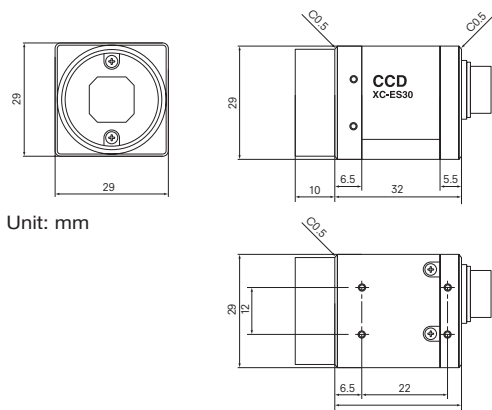

## Factory setting mode of rear panel

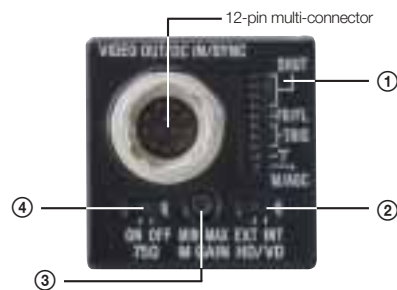

| No. | SWITCH NAME   | FACTORY-SETTING MODE    |
|-----|---|-------------------------|
| ①   | Dip switch 1-4: Shutter speed                                     | OFF                     |
|     | Dip switch 5: FRAME/FIELD   | FRAME                   |
|     | Dip switch 6-8: External trigger shutter mode, restart/reset mode | Normal                  |
|     | Dip switch 9: Gamma ON/OFF  | OFF                     |
|     | Dip switch 0: GAIN  | Manual                  |
| ②   | Manual GAIN (M GAIN) control knob                                 | Twelve o'clock position |
| ③   | HD/VD signal input/output switch                                  | EXT                     |
| ④   | 75 Ω termination switch   | ON                      |

XC-ES50L/ES50LCE

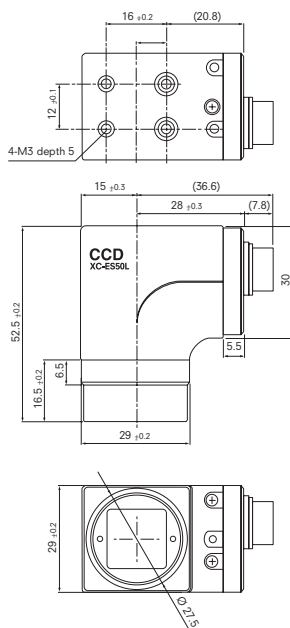

12-pin multi-connector

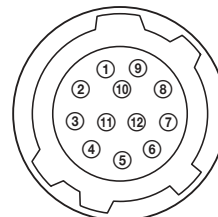

| PIN No. | EXTERNAL SYNC (HD/VD)          | INTERNAL SYNC (HD/VD)   |
|---------|--------------------------------|-------------------------|
| ①       | GND                            | GND                     |
| ②       | +12 V                          | +12 V                   |
| ③       | GND                            | GND                     |
| ④       | VIDEO output                   | VIDEO output            |
| ⑤       | GND                            | GND                     |
| ⑥       | External HD input              | Internal HD output      |
| ⑦       | External VD input <sup>1</sup> | Internal VD output      |
| ⑧       | GND                            | GND                     |
| ⑨       | -                              | -                       |
| ⑩       | WEN output <sup>2</sup>        | WEN output <sup>2</sup> |
| ⑪       | TRIG input                     | TRIG input              |
| ⑫       | GND                            | GND                     |

<sup>1</sup> HD/VD input is required when using restart, reset mode.  
<sup>2</sup> WEN output works only when in external trigger shutter mode.

## Sony Contacts

|   |                      |
|---|----------------------|
| <b>ISS for Central Zone</b><br>(Austria, Eastern Europe, Germany, Netherlands, German-speaking Switzerland) | +49 221 537 3668     |
| <b>ISS for Nordic Zone</b><br>(Baltics, Denmark, Finland, Norway, Sweden)                                   | +45 43 557 067       |
| <b>ISS for Other Zone</b><br>(UK, Ireland, Greece, Israel, South Africa)                                    | +44 1932 816 315     |
| <b>ISS for South Zone</b><br>(Belgium, France, Portugal, Spain, French-speaking Switzerland)                | +33 1 55 90 40 74    |
| <b>ISS for Italy</b>  | +39 (0) 6 334 372 27 |